

## Genuine spare parts from Praxair



Praxair Surface Technologies, Inc. engineers, manufactures and installs the most sophisticated array of **thermal spray systems** available to the global coatings market. Critical to the successful use of these systems are the **consumable components** of the various spray devices. Praxair manufactures and sells only the finest spare parts designed and manufactured specifically for thermal spray equipment, by thermal spray **equipment professionals**.

Quality gun parts determine the operating life, **robustness and repeatability** of the spray processes. Whether you use **arc spray, HVOF, plasma** or any other spray equipment, Praxair has the right replacement parts to help keep your guns, consoles and powder feeders **running consistently** and efficiently, day after day, month after month.

If your business is thermal spray coatings, then properly functioning spray equipment is **your lifblood**. Don't make the "pennywise, pound foolish" mistake of using poor imitation spare parts. Take the Praxair challenge and see how **genuine replacement parts** save you money.



**Phone:** 1-603-223-2100  
**Fax:** 1-603-225-4342  
**E-mail:** [psti-info@praxair.com](mailto:psti-info@praxair.com)  
**Web:** [www.praxair.com/thermalspray](http://www.praxair.com/thermalspray)

# Engineering at its best Precision

When deciding to invest in thermal spray equipment, a careful evaluation of the available options is made. An assessment of the financial commitments follows – a cost-benefit analysis – and, ultimately, a determination is made to spend hard-earned dollars. Quite often, extensive effort and analysis goes into purchasing thermal spray capital equipment. Yet many times, little or no thought is applied when deciding to use poor-performing imitator replacement parts.

Praxair Surface Technologies is proud of its long heritage as a provider of reliable, cost-effective thermal spray equipment to companies all over the globe. We have made it our mission to invent, design and manufacture precision spray systems to meet the emerging needs of the surface treatment and coatings markets. Integral to that task is our offering of the highest quality, best performing, genuine thermal spray replacement parts.

## Imitators just don't stack up

With tolerances specified to ensure gun operating consistency and long service life, our spare parts offer what poor imitations cannot: spray performance as designed and intended, resultant coatings of unsurpassed excellence, and true value in every sense of the word. With all of that assurance and our unparalleled customer service and coatings development, why would anyone think of using out-of-spec facsimile parts?

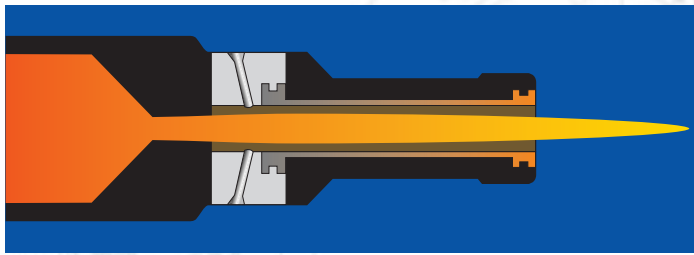

**Concentricity** and roundness, especially in the hot section of a spray gun are critical to the performance of the device. When several parts are designed to fit with others, if the centerlines do not match up and/or parts have out-of-roundness conditions, forced misalignment, reduced life, or catastrophic failure can occur. Praxair designs and manufactures for precise concentricity.

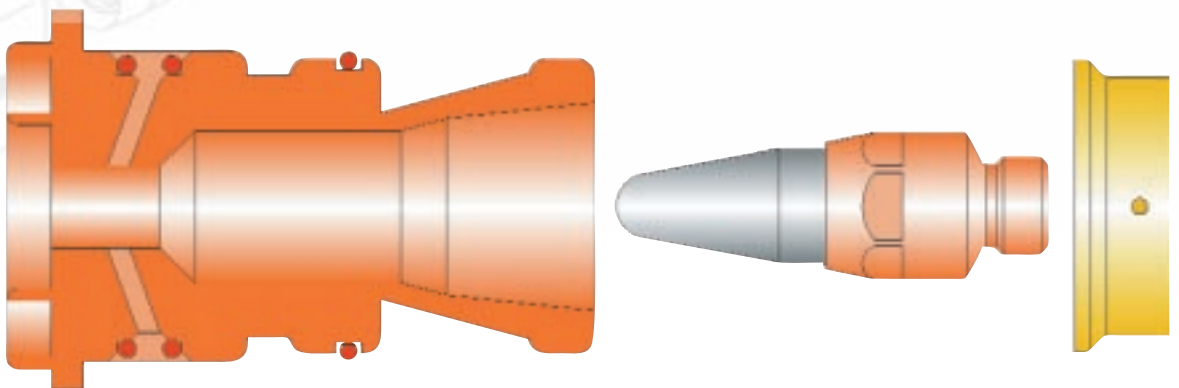

### Critical Dimensions:

Anode: Flange to Front x.xxx" + 0.000"-0.001"  
Cathode: Seat to Front x.xxx" +/- 0.003"

Aftermarket suppliers typically do not design or manufacture equipment and **stack tolerances** are overlooked or simply not considered. Individual parts are merely copied. As a thermal spray original equipment manufacturer, Praxair produces components with the understanding that 0.001" accuracy can dramatically improve or destroy performance.

## Replacement parts

# Arc

### Model 8830/8835/9000 Spare Parts

#### Contact Tips

450042	Standard Contact Tip for 1/16in. Wire
450043	Standard Contact Tip for 2mm Wire
450044	Contact Tip for 1/16in. Aluminum Wire
450045	Contact Tip for 2mm Aluminum Wire
450458	Extended Life Contact Tip for 1/16in. Wire
450604	Extended Life Contact Tip for 2mm Wire
450491	Extended Life Tip for 1/16in. Aluminum Wire
451193	Extended Life Tip for 2mm Aluminum Wire
451024	Super Long Life Contact Tip for 1/16in. Wire
451588	Super Long Life Contact Tip for 2mm Wire

#### Air Caps

450031	Blue Air Cap, Coarse to Medium Spray Pattern
450032	Gold Air Cap, Medium to Fine Spray Pattern
450033	Green Air Cap, Coarse to Medium Spray Pattern
450034	Red Air Cap, Extra Fine Spray Pattern
451116	Anti-Stick Air Cap

#### Nozzle Positioners

450027	Long Slot Nozzle Positioner, Fine Spray Pattern
450028	Long Cross Nozzle Positioner, Fine Spray Pattern
620023	Short Slot Nozzle Positioner, Hard Wire Use
620047	Short Cross Nozzle Positioner, Hard Wire Use

#### Spare Parts for 8830 and 8835

450010	Wire Drive Roller
450021	Contact Tube
450024	Side Cover Gasket
450440	Control Lever Bushing
600019	Lever, Roller Opening
600036	Guide, Wire, Short Front
600037	Guide, Wire, Long Front
600047	Arc Shield Nut, 8830, 8835, 9000
600048	Front Cover Assembly
600138	Guide, Short, Rear, QD, 8835
600139	Guide, Long, Rear, QD, 8835
600156	Guide, Short, Rear, QD, 8830
600157	Guide, Long, Rear, QD, 8830
600326	Guide, Rear, Right
600398	Alignment Housing Assembly
610003	Control Switch Assembly
620022	Pin, Front Control
620068	Pin, Dowel, Control Lever
620120	Modified Idler Gear, 8835
620151	Modified 1/4in. Gear, 8835

#### Spare Parts for 8830 and 8835 ArcJet™ Spray Attachment

800152	ArcJet Retrofit Kit for 8830 and 8835
450448	ArcJet Plenum Housing
450729	ArcJet Air Cap
620074	ArcJet Nozzle Positioner
620075	ArcJet Front Cover Assembly
620101	ArcJet Arc Shield Nut

#### Spare Parts for 9000

450506	Front Wire Guide
450600	Front Cover Assembly
450615	Double Grommet
450819	Drive Roll Shield
450859	Contact Tube
600056	Potentiometer
600250	Drive Roller
600391	Alignment Housing Assembly
600325	Guide, Rear, Left
800227	Remote Start/Stop Switch



Arc Spray Spares



TATA developed an improved alignment housing for the 8830, 8835 and 9000. It's a durable one-piece construction machined from a material that resists high heat and wear under heavy usage.



The ArcJet attachment enables increased particle velocity and concentration of the spray stream. Customers can retrofit existing Praxair equipment by installing the ArcJet attachment kit. The kit includes the plenum housing, ArcJet arc shield nut, ArcJet air cap, ArcJet nozzle positioner, and installation instructions.



## Replacement parts

# Arc

### Model 9935 Spare Parts

#### Spare Parts

451503	Worm Shaft
451859	Power Manifold
451860	Top Housing
451861	Bottom Housing
451862	Conductor Release Cover
451865-1	Right Side Terminal Clamp
451865-2	Left Side Terminal Clamp
600607	Coupling Barrel, QD
601235	Alignment Housing Assembly
601236	Right Side Cover
601237	Left Side Cover
601238	Current Tube Assembly
610436	Control Cable
610447	Gun Volt Cable Assembly



BP-400 Spares

### Model BP-400 Spare Parts

#### Wire Guides

05000392	Standard Wire Guide for 1/16in. Wire
451834	Standard Wire Guide for 2mm Wire
05000391	Standard Wire Guide for 11 Ga Wire
05007147	Extended Life Wire Guide for 1/16in. Wire
05000981	High Velocity and Fanspray Wire Guide for 1/16in. Wire
451835	High Velocity and Fanspray Wire Guide for 2mm Wire
05004992	High Velocity and Fanspray Wire Guide for 11 Ga Wire
01313110	Standard Hard Wire Guide for Extension
01313120	Standard Soft Wire Guide for Extension
01323110	11 Ga Wire Guide for Hard Wire, for Extension
01323120	11 Ga Wire Guide for Soft Wire, for Extension

#### Drive Rolls

0M053706	Drive Roll, 14 Ga, U-Groove, for Soft Wires
05000628	Drive Roll, 14 Ga, V-Groove, for Hard Wires
0M053704	Drive Roll, 2mm, U-Groove, for Soft Wires
0M079610	Drive Roll, 2MM, V-Groove, for Hard wires
05000346	Drive Roll, 11 Gauge, U-Groove, for Soft Wires
0M132961	Drive Roll, 11 Gauge, V-Groove, for Hard Wires

#### Spare Parts

05000019A	Standard Air Cap, 14 Ga, 2mm, 11 Ga
05006194	Air Cap Shield
02509100	Adaptor for Atomizing Air Hose
05001166	Guide, Wire Coaxial Cable, 14 Ga, 11 Ga
05000313	Motor Speed Circuit Board, PF400R
05000352	Guide, Control, 14 Ga, 11 Ga, Console
05000630	Gear, Spur, Insulated
05004604	Gear With Bearing for Drive Roll Assembly
05004737	Fanspray Air Cap for 1/16in. and 2mm Wire
05004993	Fanspray Air Cap for 11 Ga Wire
05004738	Clamp Ring for Fanspray Kit Assembly
05004734	Air Cap, for High Velocity
05002656	Standard Nozzle for BP-400 Extension Gun
05000824	11 Ga Nozzle for BP-400 Extension Gun

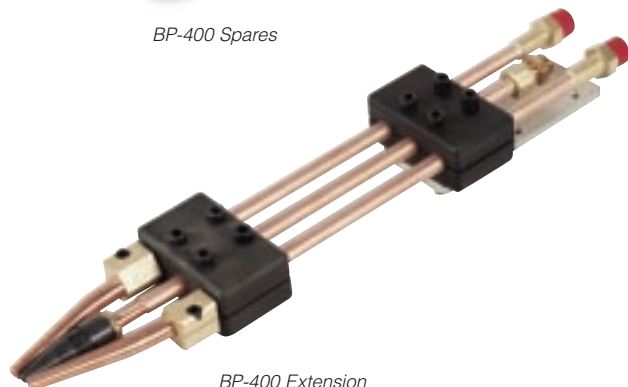

BP-400 Extension Components



Rely on Praxair's high quality contact tips for your arc spray guns. Standard contact tips, as well as long-life contact tips, are available for different sized wires. Praxair designs and manufactures tips and guides for Models 8830, 8835, 9000, 8850, BP-400, 9935 and extensions.

# Replacement parts

# HVOF

## Model 5220/5250ST/ST-4000 Spare Parts

### Barrels

600480	Barrel w/O-Ring, 2.5in., for 5220
600460	Barrel w/O-Ring, 4in., for 5220
600461	Barrel w/O-Ring, 6in., for 5220
600462	Barrel w/O-Ring, 8in., for 5220
600463	Barrel w/O-Ring, 12in., for 5220
601148	Barrel Assembly, for 5250ST and ST-4000
601147	Barrel Holder, for 5250ST and ST-4000
600636-2	Barrel, for Metallics, for 5250ST and ST-4000
451563	Barrel, for Carbides, for 5250ST and ST-4000

### Coaxial Stabilizer Parts

600392	Coaxial Stabilizer Assembly, for 5220
600727	Coaxial Stabilizer Assembly for 5250ST
601170	Coaxial Stabilizer Assembly, for ST-4000
210539	Elbow Tube, 1/8in. (replaces 620178), for 5220 and 5250ST
230013	O-Ring, Coaxial Tube, Rear, for 5220
230248	O-Ring, Coaxial Tube, Front, for 5220
410113	Check Valve, Fuel for Coaxial Stabilizer, for 5220 and 5250ST
410165	Check Valve, Oxygen, for Coaxial Stabilizer, for 5220
450875	Electrode, for 5220
451554	Electrode, Ignition, for 5250ST and ST-4000
451571	Fitting, Oxygen, for 5250ST and ST-4000
600408	Spark Plug Assembly, for 5220
600464	Combustion Pressure Heat Tube Assembly, for 5220
600729	Atomizer Assembly, for 5250ST and ST-4000
600732	Atomizer, for 5250ST and ST-4000
600733	Plunge Assembly, for 5250ST and ST-4000
630062	Spare Plug Assembly, for 5250ST and ST-4000

### Spare Parts

210042	Ferrule, 1/4in. Plastic, for 5220
210077	Nipple, Fuel Check Valve, for 5220
210081	Nipple, Oxygen Check Valve, for 5220
210364	Nut, 1/4in. Tubing, for 5220
230209	O-Ring, Combustion Chamber, for 5220
230211	O-Ring, Barrel, Back, for 5220
230261	O-Ring, Barrel, Front, for 5220
450648	Mounting Plate, for 5220
450922	Interconnector, for 5220
450924	Combustion Chamber, for 5220, 5250ST and ST-4000
450925	Powder Feed Tube, for 5220, 5250ST, and ST-4000
451163	Powder Feed Tube Insert, long life
451163	Powder Feed Tube Insert, for 5220
451352	Interconnector, for 5250ST and ST-4000
451353	Combustion Chamber, for 5250ST and ST-4000
451567	Elbow, Water Return, for 5250ST and ST-4000
451568	Tube, Water Return, for 5250ST and ST-4000
451832	Combustion pressure fitting, (replaces 450392), for 5220
600359	Gun Mount, for 5220
600418	Tool Kit, for 5220
600512	Spare Parts Package, 500-Hour, for 5220
600513	Spare Parts Package, 1,000 Hour, for 5220
601173	Tool Kit, for 5250ST and ST-4000
601182	Spare Parts Package, for 5250ST and ST-4000
620180	Powder Port Fitting, for 5220, 5250ST and ST-4000
800250	Remote Pendant, for 5120, 25ft
800437	Remote Pendant, for 5120, 50ft



The 4in., 6in. and 8in. barrels are the most common for Praxair's HP/HVOF® equipment. Application, powder type, and spray parameters determine barrel selection.



HVOF Spares

**The coaxial stabilizer assembly** (P/N 600392) is the most critical part of the 5220 Gun. Fuel is atomized into fine droplets by the oxygen in the coaxial stabilizer.

Praxair's coaxial stabilizer is manufactured, assembled, and tested at our facility. The tests are performed on a calibrated JP-5000® system to internal specifications.

The coaxial stabilizer assembly includes the main stabilizer body, adaptors, fittings, check valves, coaxial tube assembly and spark plug assembly.

**Test requirements** on the coaxial stabilizer assembly include a check and pass process at given flows on a calibrated console:

#### Check:

- Pop-Back
- 0° Back Pressure
- Combustion Back Pressure
- Fuel Pressure

#### Pass:

- No Pop-Back
- Pressure Valves Remain Constant
- Stable Flame
- Smooth, Consistent Starts



The combustion pressure heat tube assembly (P/N 600464) is a component for the 5220 gun connecting the combustion line to the coaxial stabilizer. If extreme heat passes through the stabilizer into the combustion line, this assembly reduces the temperature, prolonging the life of other components. Praxair's combustion pressure heat tube assembly is manufactured to the latest revision level available exclusively from Praxair.

# Replacement parts

# Plasma

## Model SG-100/SG-200/2086A/2700 Spare Parts

### Anodes

02083-730	Anode, NVS, Standard, for SG-100
03083-145	Anode, Subsonic, 10 Degree, 0.125in., for SG-100
03083-165	Anode, Subsonic, 10 Degree, 0.078in., for SG-100
03083-175	Anode, Subsonic, 90 Degree, 0.078in., for SG-100
02083-355	Anode, Mach I, 10 Degree, 0.125in., for SG-100
02083-358	Anode, Mach I, 90 Degree, 0.078in., for SG-100
02083-155	Anode, Mach I, 10 Degree, 0.078in., for SG-100
02083-100	Anode, Mach II, 10 Degree, 0.096in., for SG-100
01230A-400	Anode, for SG-200
02084-F45	Anode, Standard, 45 Degree, for 2086A
02084-F60	Anode, 60 Degree, for 2086A
02700-200	Anode, Standard, 45 Degree, for 2700
02700-203	Anode, Straight, for 2700

### Cathodes

01083A-720	Standard, NVS, for SG-100
03083-129	Cathode, Subsonic, for SG-100
01083A-112	Cathode, Mach I, for SG-100
01083A-104	Cathode, Mach II for SG-100
01230A-401	Cathode, for SG-200
03083-129	Cathode, for 2086A
01068-ROO	Cathode, for 2700

### Gas Injectors

03083-112	Gas Injector, Standard, NVS, for SG-100
03083-113	Gas Injector, Subsonic/Mach I, for SG-100
03083-110	Gas Injector, Mach II, for SG-100
01230A-402	Gas Injector, for SG-200
02084B-103	Gas Injector, for 2086A
02700A-120-1	Gas Injector, Front, for 2700
02700A-120-2	Gas Injector, Rear, for 2700

### Gun Housings

01083A-122N	Housing, Middle, for SG-100, 2086A and 2700
01083B-200	Housing, Front, for SG-100, 2086A and 2700
01083B-205I	Housing, Rear, for SG-100, 2086A and 2700
01230A-400	Housing, Front, for SG-200
01230A-401	Housing, Middle, for SG-200
01230A-402	Housing, Rear, for SG-200

### Spares

01083-10	Tube, Arc Gas Port, for SG-100, 2086A and 2700
01083A-107A	Plug, Powder Port, for SG-100, 2086A and 2700
01083A-108	Cathode Holder, for SG-100, 2086A and 2700
02083-123	Plate, Front Cover, for SG-100
05004376	Adapter, Cable, for SG-100
05004378	Tube, Powder Tube, for SG-100
02084-77	Tube, Divider, for 2086A
02084-80	Ring, Locking, for 2086A
02084-81	Plate, Front Cover, for 2086A
02084-82	Collar, Locking, for 2086A
02084A-74	Tube, Outside, for 2086A, available in 12in., 24in., 36in., 48in.
02084A-75	Tube, Divider, PVC, for 2086A, available in 12in., 24in., 36in., 48in.
02084A-76	Cathode Holder, for 2086A, available in 12in., 24in., 36in., 48in.
02084A-83	Tube, Powder Assembly, for 2086A, available in 12in., 24in., 36in., 48in.
02084A-85	Tube, Air Assembly, 45 degree, for 2086A, available in 12in., 24in., 36in., 48in.
02084B-100	Gun Housing Middle Insulator, for 2086A
02084B-101	Water Divider, Outlet, for 2086A
02084B-102	Gas Distributor, for 2086A
02700-004	Cathode Holder, for 2700, available in 12in., 24in., 36in., 48in.,
02700-005	Tube, Assembly, Powder, for 2700, available in 12in., 24in., 36in., 48in.
02700-101	Tube, Outer, for 2700, available in 12in., 24in., 36in., 48in.
02700-102	Tube, Water, for 2700, available in 12in., 24in., 36in., 48in.

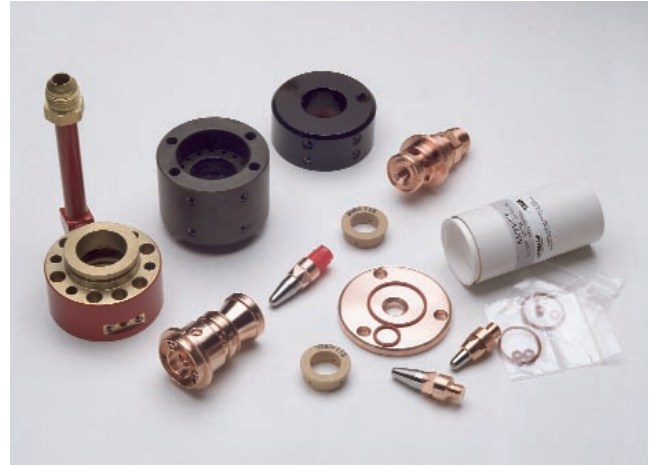

Plasma Spares

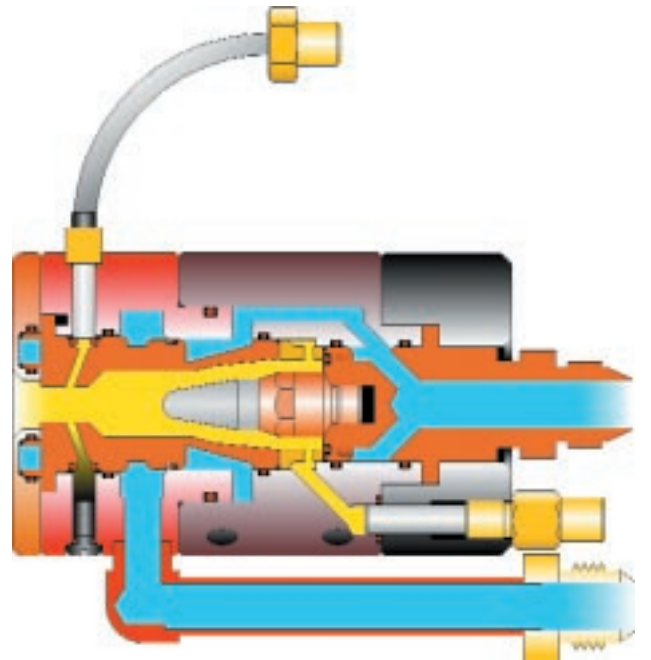

**The parts within the SG-100** are designed to be self-aligning and assembled easily and quickly while maintaining concentricity; i.e., the center line of the electrode on the axis of the nozzle (anode). The more precise this alignment is, the more centered the arc is within the nozzle. Good concentricity and proper gas flow patterns produce:

- Minimum heat loss to the nozzle
- Long nozzle (anode) life
- Simpler more reliable powder injection into the plasma stream
- Minimal nozzle powder buildup
- Improved coatings (through improved powder injection, maximum heat to the powder and symmetrical arc position on the axis of the anode).

## Replacement parts

# Hoses and Cables

### Hoses and Cables

#### Hoses and Cables - Arc

800095	Hose and Cable Set, Standard, 12ft, for 8830
600041-12	Air Motor Air Hose, 12ft, for 8830
600043-13	Atomizing Air Hose, 13ft, for 8830
600128	Power Cable, QD, 12ft, for 8830
610005	Control Cable, 12ft, for 8830
800047-10	Wire Conduits, Steel, 10ft for 8830 and 8835
800316-10	Wire Conduits, Teflon, 10ft for 8830 and 8835
220105	Teflon Conduit, Liner for 800316, for 8830 and 8835
800109	Hose and Cable Set, 12ft, for 8835
600302	Atomizing Air Hose, 90 Degree, 13ft, for 8835
600190	Power Lead Cable, QD, 12ft for 8835
800307	Hose and Cable Set, Standard, 10ft, for 9000
610116	Control Cable, 10ft, for 9000
800266	Wire Conduits, Teflon, 10ft, for 9000
220105	Teflon Conduit, Liner for 800266, for 9000
05005233-10	Coaxial Cable, Standard, 10ft, for BP-400
05000659-10	Atomizing Air Hose, 10ft, for BP-400
05000660-15	Power Cable, Positive, 15ft, for BP-400
05002298-15	Power Cable, Negative, 15ft, for BP-400
610219-15	Control Cable, Console, 15ft, for 8835 and BP-400
600046	Air Supply Hose, 20ft, for 8830, 8835 and 9000
05000487	Cable, INTRL, 2/O, 13.5in., Console, for BP-400

#### Hoses and Cables - HVOF

800386-20	Hose and Cable Set, Standard, 20ft, for 5220
800766-20	Hose and Cable Set, Standard, 20ft, for 5250ST
600333	Fuel Hose, 20ft, for 5250ST
600335-20	Water Hose, 20ft, for 5220 and 5250ST
600417-20	Water Hose, 20ft, for 5220 and 5250ST
600432-20	Oxygen Hose, 20ft, for 5220 and 5250ST
610179-20	Ignition Cable, 20ft, for 5220 and 5250ST
610180-20	Ignition Cable, 20ft, for 5220 and 5250ST
800249	Hose Supply Package, Console, 15ft, for 5120
600220-15	Oxygen Hose, Green, Console, 15ft, for 5120
600309	Water Supply Return Hose, Console, for 5120
600311-15	Fuel Supply Return Hose, Console, for 5120
600339	Air Hose, 15ft, Console, for 5120

#### Hoses and Cables - Plasma

05005028	Power Cable, Console, for 3710 and 3620
05007777-20	Control Cable, E-Stop, 20ft, Console, for 3710 and 3620
05005064-25	Air Supply Hose, 25ft, Console to Air Supply, for 3710 and 3620
05005071-25	Gas Supply Hose, 25ft, Inert, Console to Gas Supply, for 3710
0987-7-25	Gas Supply Hose, 25ft, High Pressure, Console to Gas Supply, for 3620
05005067-25	Gas Fuel Hose, 25ft, Hyd/Ace, Console to Gas Supply, for 3710
05008449-25	Gas Fuel Hose, 25ft, Console to Fuel Supply, for 3620
0985-2-12	Gas Hose, 12ft, Console to Powder Feeder/Gun, for 3620
05008540-25	Power Cable, Auxiliary, Console, 25ft, for 3710
05005224-25	Control Cable, 25ft, HF-2200 to Console, for 3710
05005222-25	Control Cable, 25ft, HF-2200 to Console, for 3710
05005272-25	Control Cable, 25ft, 3702 to HF-2200, Volt
05005001-20	Control Cable, 20ft, for 3620
05001299-25	Control Cable, 25ft, Console to Power Sply, for 3620
05005002-25	Control Cable, 25ft, Console to HF-2200, for 3620
05005005-25	Control Cable, 25ft, Console to HF-2200, for 3620
05005006-30	Control Cable, 30ft, Console to HF-2200, Volt, for 3620
0984-33-8	Power Cable, Negative, 8ft, HF-2200
0984-18-8	Power Cable, Positive, 8ft, HF-2200
0987-7-12	Water Cooled Cable, Negative, 12ft, HF-2200 to Gun, for SG-100
0987-8-12	Water Cooled Cable, Positive, 12ft, HF-2200 to Gun, for SG-100
05005265-25	Control Cable, 25ft, 3202 Pump, Console to Heat Exchanger, for 3710
05005297-25	Control Cable, 25ft, 3202 Pump, Console to Heat Exchanger, for 3620
0986-6-12	Water Hose, 12ft, Pump, for 3202
05008637-25	Cable, 25ft, PS-1000, Junction Box to Console, for 3710
05008631-25	Cable, 25ft, PS-1000, Junction Box to Console, for 3620



Hoses and Cables

Hoses and cables are essential parts for thermal spray equipment. Praxair provides hoses and cables for appropriate flow of air, gas, water and electrical current. Hose and cable assemblies include proper fittings, adapters, connectors, and are available in several different lengths.



2086A ID Plasma Extension Hoses and Cables

# Replacement parts

# Other

## Other Spare Parts

### Model 1264 Powder Feeder Parts

01250-106	Surface Ring
01251-113	Kit, Ring-Felt
01250-108	Ring, Back-Up
01250-308	Pad, Felt
01250-114	Ring, Felt
01224A-107	Ring, Barrier (Felt)
015910	Ring, Wiper
01251-102	Kit, O-Ring
01250-107	Sleeve, Powder Out
01250-224	Cam, Lifter
01253-108	Ring, Back-Up, High Volume
01252-111	Kit, Repair, Solenoid, Valve
01253-106	Ring, Surface, High Volume
01253-114	Ring, Felt, High Volume
012010	Bearing, Double Row Ball
05002289	Washer, Cupped Spring Curve
014030	Valve, Pressure Relief, 90 PSI
01250-233	Tamper Bar, Anodized
05005028	Power Cable, for 1264
610312-12	Interface Cable, 12ft, 5120 to 1264
05005293-20	Control Cable, 20ft, 3710 to 1264
05005360-20	Control Cable, 20ft, 3620 to 1264
05003767	Tubing, Clear, for 1264
220021	Tubing, 1/4in., Air to Console, Console to 1264

### Powder Feeder Wheels

01250-109	Powder Feeder Wheel, Standard
05008643	Powder Feeder Wheel, 120-Hole
01250-141	Powder Feeder Wheel, for Fine Coatings
01253-109	High Volume, for Coarse Coatings
451760	Powder Feeder Wheel, 240-Hole

### Competitor Spares

230045	O-Ring for Plasma T2M11 Electrode
230047	O-Ring for Plasma Nozzles
230055	O-Ring for Plasma Nozzles
T2M11	Electrode for Plasma 3M
T3M7-G	G Nozzle for Plasma 3M/7M/9M
T3M7-GE	GE Nozzle for Plasma 3M/7M/9M
T3M7-GH	GH Nozzle for Plasma 3M/7M/9M
T3M7-GP	GP Nozzle for Plasma 3M/7M/9M
T3M275	Distributor Ring for Plasma 3M, Argon
T3MBTD	Distributor Ring for Plasma 3M, Nitrogen
T3M210	Powder Port for Plasma 3M
T7M63	Electrode for Plasma 7M
T9M63	Electrode for Plasma 9M
T1003649	Nozzle for Plasma F100, 340102-11



Powder Feeder Spares

**Competitive Spares** product line consists of high volume spare parts for non-TAFA thermal spray equipment. The spare parts are manufactured by Praxair in Concord, New Hampshire. As an original manufacturer of thermal spray equipment, we are committed to quality. Processes for manufacturing spare parts for the traditional TAFA equipment are used for manufacturing the competitive spares, including in-depth material analysis, precise measuring, and extensive testing using OEM equipment. The following chart indicates results of a life test of Praxair's G-Nozzle. Our goal is to produce spare parts of OEM quality. In this case, the Praxair version outlasted the OEM's version. The availability of competitive spares enable customers to obtain all high volume thermal spray equipment spare parts from one dependable source.

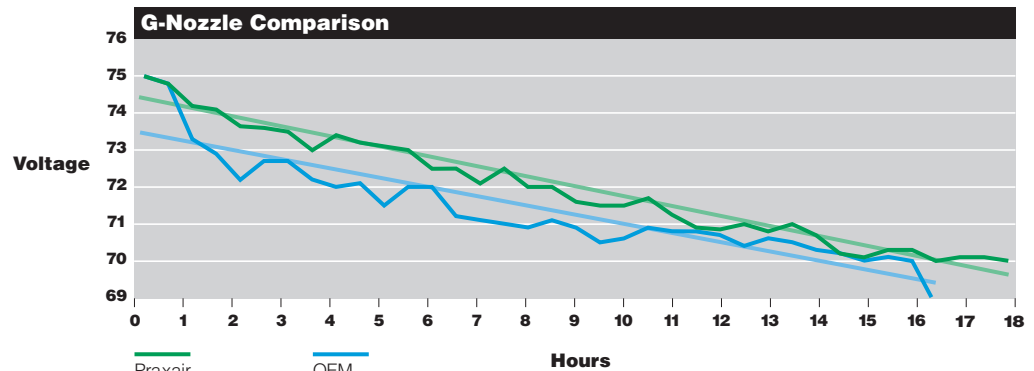

## Quality components that meet the highest standards

# On Target

With on-site engineering, programming and CNC manufacturing capability, Praxair holds the key to producing the finest thermal spray replacement parts available. Unlike inexpensive imitators, we develop and specify the tolerances for our gun and equipment components, and we understand why those dimensions are important in the operation of the spray systems. Best of all, we work to the standard of continuous improvement, aiming our manufacturing at specific tolerance targets or specification centerlines.

We don't measure success by simply meeting dimensional tolerance limits, we utilize Statistical Process Control (SPC) and Six Sigma tools to determine how to home in on the desired dimensional targets. And our efforts produce results – as customer after customer remains loyal to Praxair for all of its spare parts needs. Real value comes from consistent performance and getting what you pay for, not paying a slightly lower price for a storage cabinet full of problems.



Look for the TFA symbol for high quality, genuine thermal spray equipment spare parts

Our skilled programmers utilize sophisticated programming software and State-of-the-Art machining centers to bring engineered components to life. We use an array of equipment – from CNC lathes, to CNC vertical machines, to Swiss turning centers, and even manual mills and lathes – to produce the best parts in the most cost-effective manner. Keep your investment running properly and efficiently by using only genuine replacement parts from Praxair.

*Below: Praxair's Machine Shop evolved from prototype and short run manufacturing to manufacturing 90+% of spare parts for all equipment lines. The expanded facility is equipped with bar-fed CNC lathes, vertical CNC centers, and barfed Swiss-style machines. The fully capable machine shop also includes in-process inspection, coordinate measuring machine, drilling centers and a highly critical finishing cell. In-house production enables Praxair control of quality, cost and inventory.*



*Left: Highly technical machining functions would not be possible without properly skilled personnel. Praxair's advanced programmers implemented lean manufacturing processes and strong Six Sigma initiatives. Praxair has the right people and processes to fulfill customers' thermal spray spare parts needs.*

Equipment solutions  
for all your needs

# Full Service



**HVOF** – High pressure, high velocity equipment for dense, hard, low-oxide coatings. Options include the exciting new JP-8000, the legendary JP-5000® and the ST-4000 systems.



**ARC** – Versatile family of systems to spray solid and cored wires very cost-effectively. Choose from the 8835, the lightweight BP-400, the “classic” 8830, or the advanced *CoArc™* system.

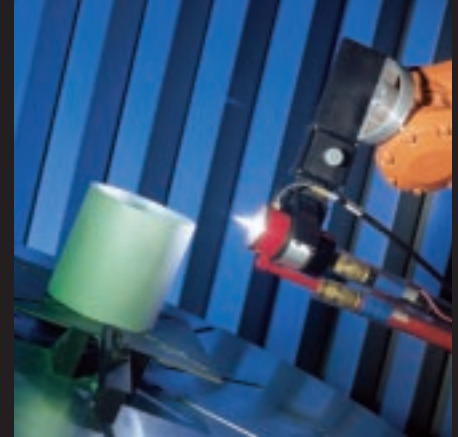

**PLASMA** – Innovative and versatile SG-100 systems range from the simple 3710 console up to the 7700UPC with net energy.



**POWDER FEEDERS** – The renowned 1264 model has an unmatched performance history. Closed loop, weight-loss control also is available with the 1280 feedrate controller.



**TURNKEY SYSTEMS** – All-in-one integrated solutions include spray booth, dust collection, handling equipment, spray devices and controls in one neat, engineered package.



**ANCILLARY EQUIPMENT** – From robots to turntables, chillers to dust collectors, lathes to gantries... whatever you need to spray with, we have it.



© Copyright 2005 Praxair Technology, Inc.  
All rights reserved

Praxair Surface Technologies, Inc.  
1555 Main Street  
Indianapolis, IN 46224  
USA

*Telephone:*  
(317) 240-2650

*Fax:*  
(317) 240-2596

Praxair Services GmbH & Co. KG  
Am Muhlbach 13  
D-87487 Wiggensbach  
Germany

*Telephone:*  
+49-(0) 8370-9207-0

*Fax:*  
+49-(0) 8370-9207-20

[www.praxair.com/thermalspray](http://www.praxair.com/thermalspray)  
[psti-info@praxair.com](mailto:psti-info@praxair.com)

*Praxair and the Flowing Airstream design are trademarks or registered trademarks of Praxair Technology, Inc., and JP-5000, HP/HVOF, ArcJet, CoArc, TAFAs, TAFAs with Flame design, and the Flame design are trademarks or registered trademarks of Praxair S.T. Technology, Inc., in the United States and/or other countries.*

The information contained herein is offered for use by technically qualified personnel at their discretion and risk without warranty of any kind.

Printed in the United States of America  
09-2005

TAFAs Incorporated  
146 Pembroke Road  
Concord, NH 03301  
USA

[www.praxair.com/thermalspray](http://www.praxair.com/thermalspray)  
[psti-info@praxair.com](mailto:psti-info@praxair.com)

*Telephone:*  
(603) 224-9585

*Fax:*  
(603) 225-4342

Praxair is committed to continuous product improvement. Specifications, appearances and dimensions are subject to change without notice.

TAFAs Incorporated is a Praxair Surface Technologies company.

All product photographs are not to scale and should be used for information only. Photos might not represent the latest product revision and should not be used for comparison purposes.